

Frozen Frozen granita dispenser with 3 bowls, electronic control, UV light

ITEM # _____

MODEL # _____

NAME # _____

SIS # _____

AIA # _____



562538 (IPRO3EUVR290) Frozen Granita Dispenser with 3X11 l insulated bowls, UV light, electronic control, R290

Short Form Specification

Item No. _____

Frozen granita dispenser with 3 bowls; the ITANK™ Technology prevents ice accumulation on the outer side of the bowl and the bowl shape allows a natural mixing action to ensure an optimum consistency of the product. Customizable lid merchandiser and back graphic. Exclusive nUV LED system for bowl sanitation. Electronic control system and touch screen keypad. Sliding drip tray.

Main Features

- Ideal for the production of slush.
- The ITANK™ Technology prevents ice accumulation on the outer side of the bowl, reducing condensation and increasing the cooling power of the machine.
- Bowl shape allows a natural mixing action to ensure an optimum consistency of the product.
- Customizable lid merchandiser and back graphic.
- Daily and weekly machine programming functionality.
- The insulated tank guarantees higher cooling efficiency and lower effect of the external temperature on product's preparation and maintenance time reducing condense and draining; it is the best solution in hot climate conditions.
- Exclusive nUV LED system for bowl sanitation.

Construction

- Electronic control system and touch screen keypad.
- Sliding drip tray.

Sustainability

- When the product reaches the right consistency, an automatic stand-by mode activates in order to save energy and reduce CO2 emissions.



APPROVAL: _____

Front

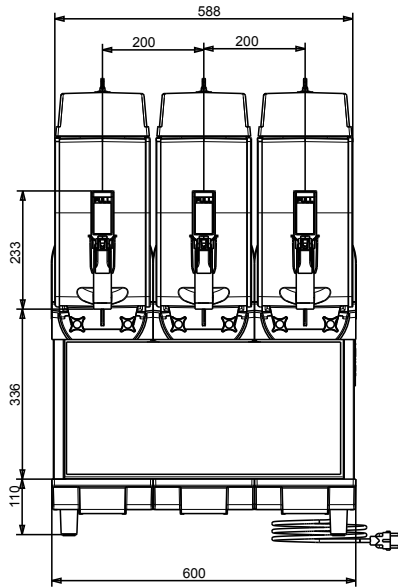

Side

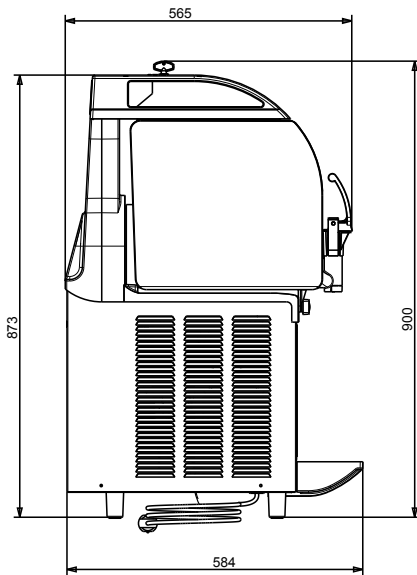

Top

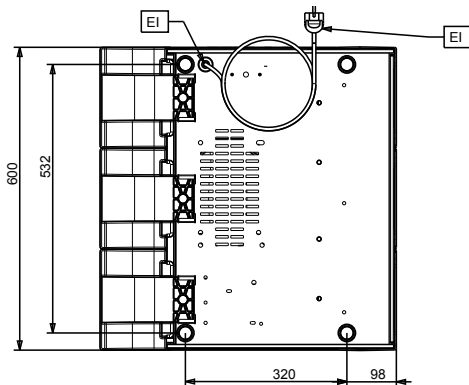

Electric

Supply voltage:

562538 (IPRO3EUVR290) 220-240 V/1 ph/50 Hz

Electrical power max.:

1.45 kW

Key Information:

External dimensions, Width: 600 mm

External dimensions, Depth: 580 mm

External dimensions, Height: 870 mm

Net weight: 81 kg

Sustainability

Refrigerant type: R290